

N sesi bulunan varlıkların altındaki kutuyu işaretleyelim.

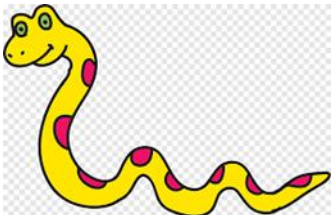

### Başında - Ortasında - Sonunda

Görsellerin adında 'n' sesi başta ise baştaki kutuyu , içinde ise ortadaki kutuyu , sonda ise sondaki kutuyu işaretleyelim. Eğer daha fazla 'n' sesi varsa birden fazla kutuyu işaretleyelim.

N harfini ok yönünde yazalım. Aşağıdaki satırları dolduralım.

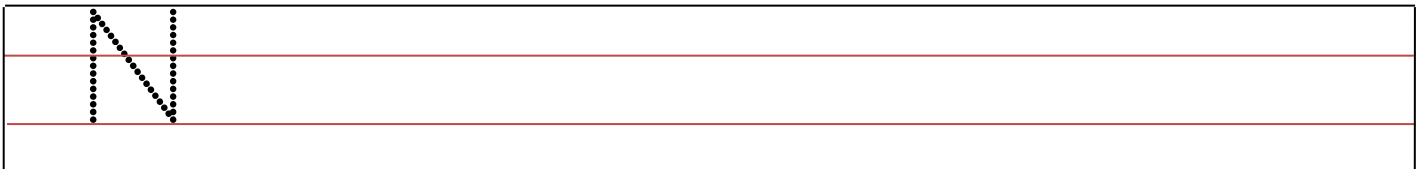
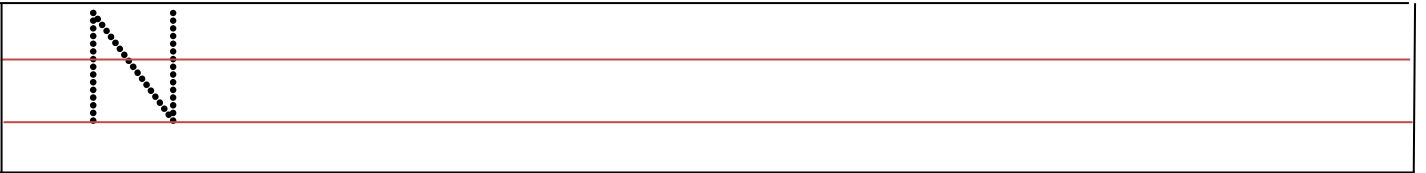
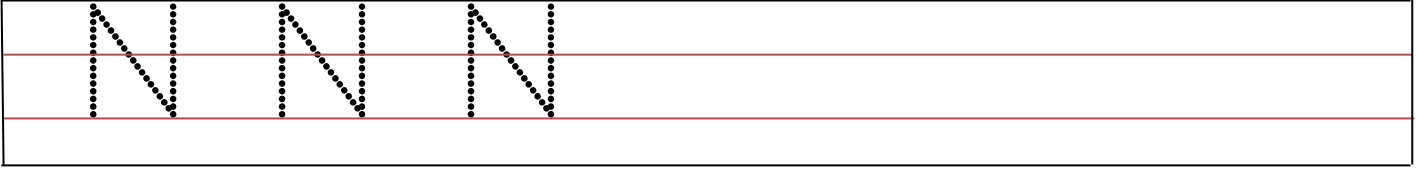
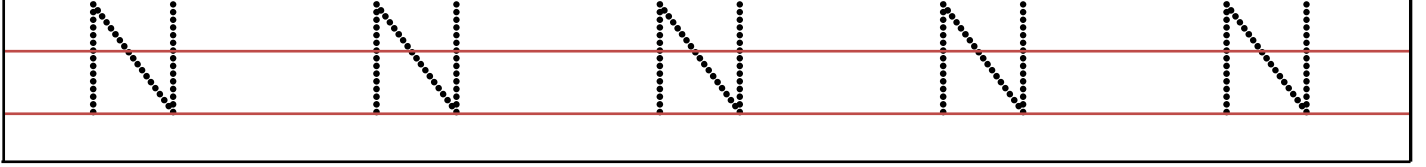
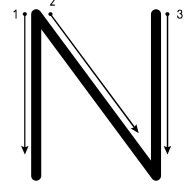
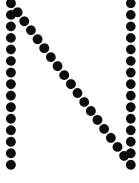

n harfini ok yönünde yazalım , boşlukları tamamlayalım.

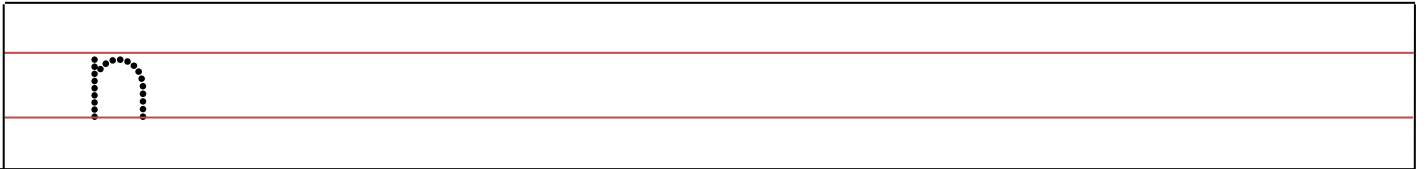
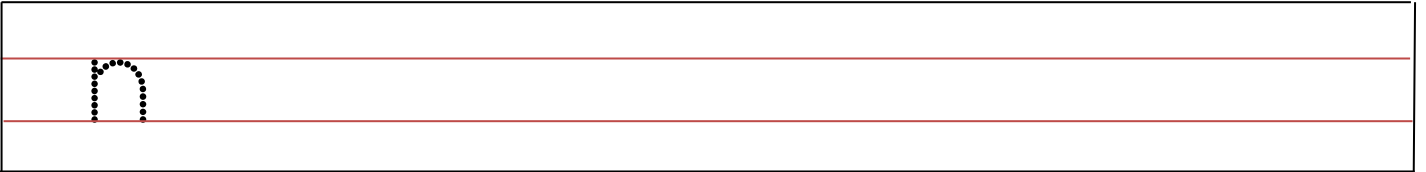
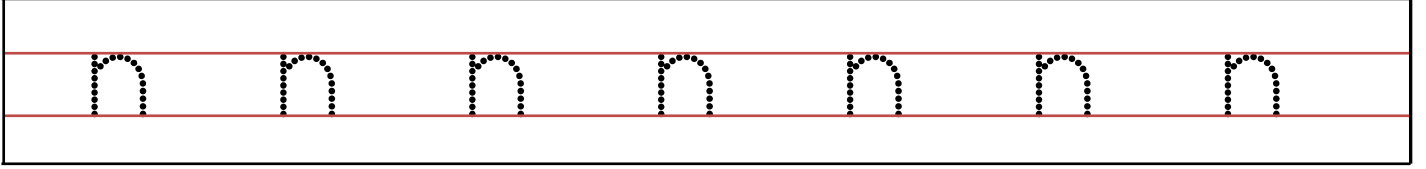
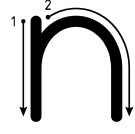
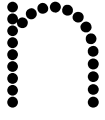

N ve n harflerini yazalım. Aşağıdaki satırları dolduralım.

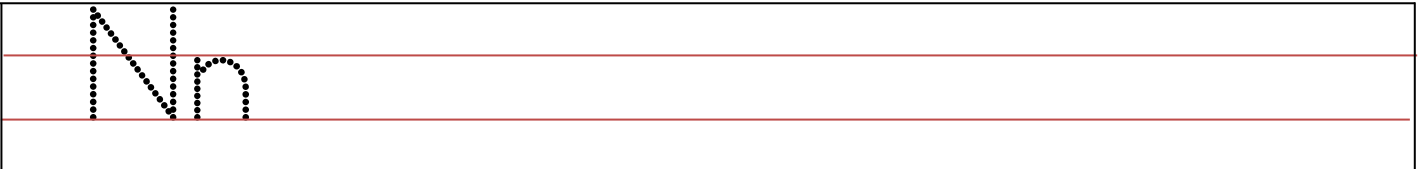
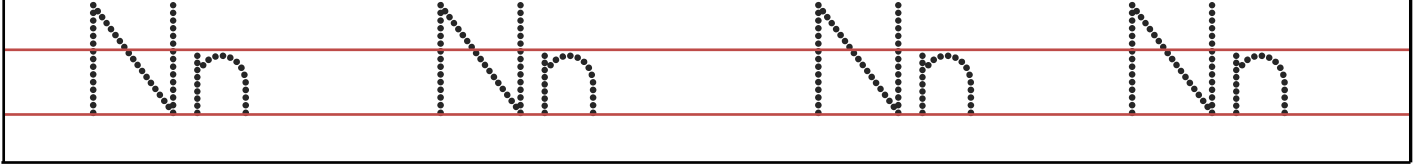
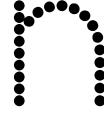
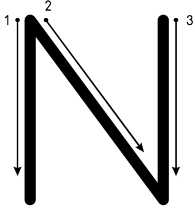

Aşağıdaki elmalardan N olan elmayı kırmızıya , n olan elmayı sarıya boyayalım.

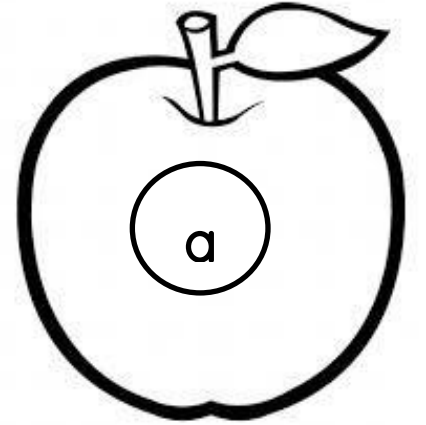
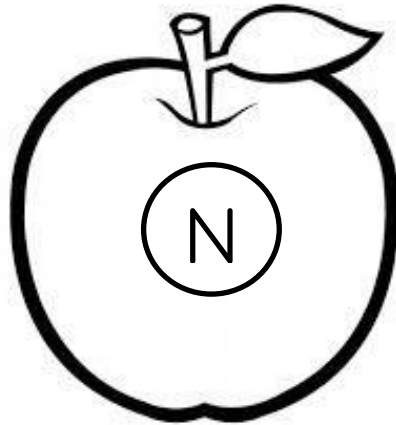
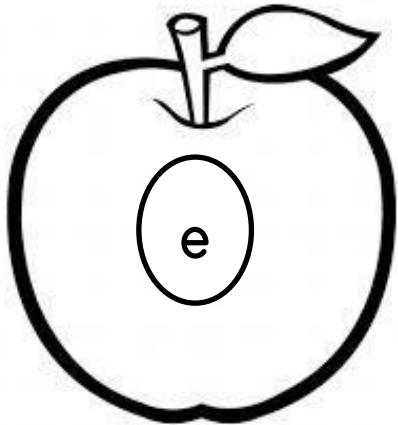
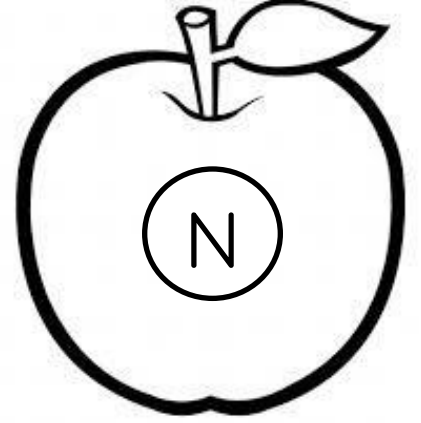
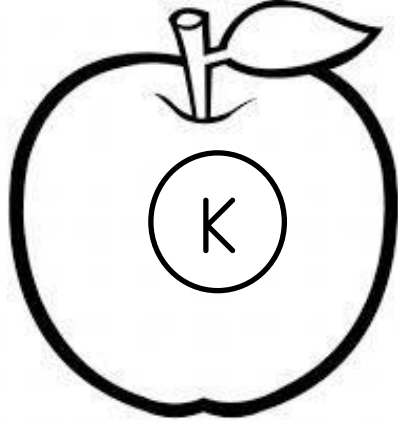
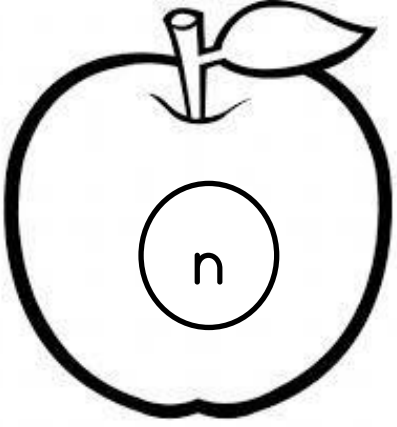
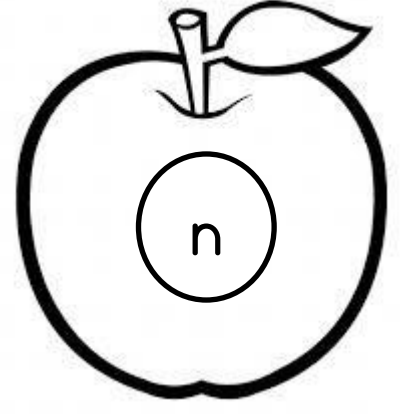
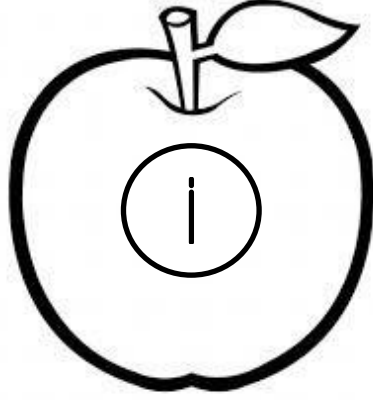
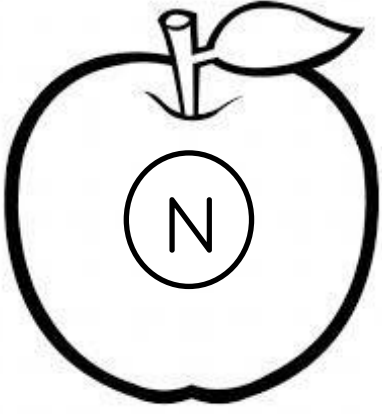

Ş.A

Okuyalım , yazalım.

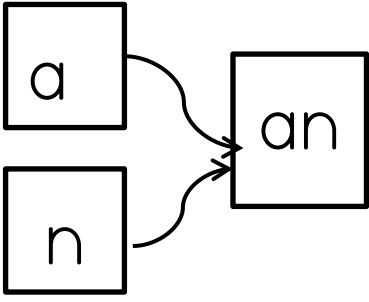

an an an

an

an

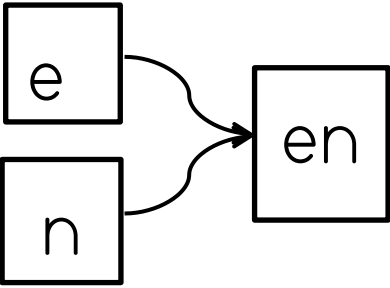

en en en

en

en

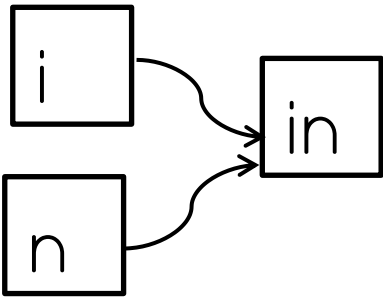

in

in

in

Okuyalım , yazalım.

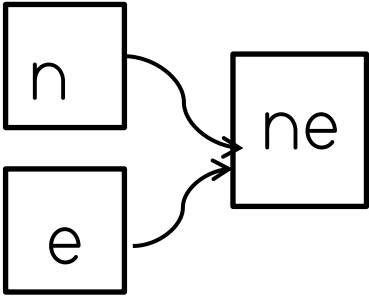

ne ne ne

ne

ne

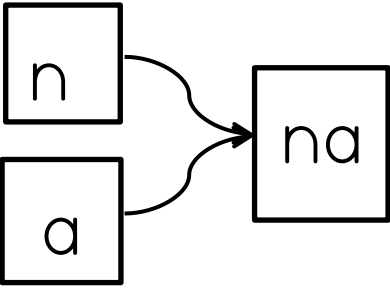

na na na

na

na

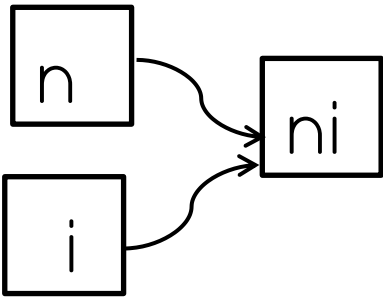

ni

ni

ni

Okuyalım , yazalım.

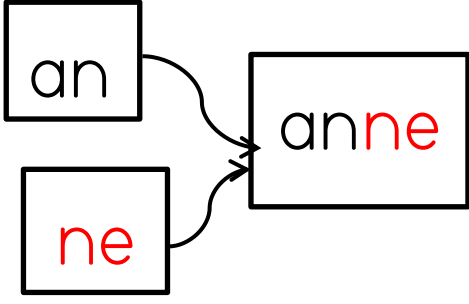

anne anne

anne

anne

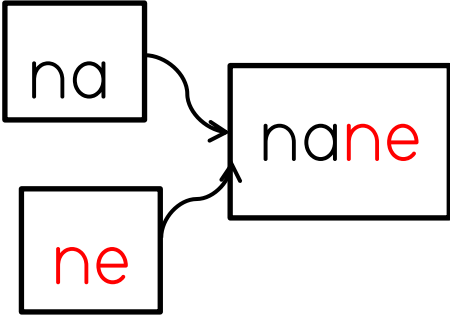

nane nane nane

nane

nane

4

4

3



Okuyalım , yazalım.

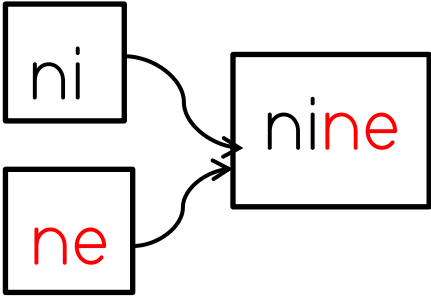

nine nine nine

nine

nine

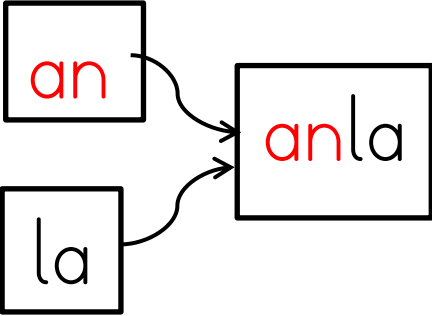

anla

anla

anla

1

2

3

Okuyalım , yazalım.

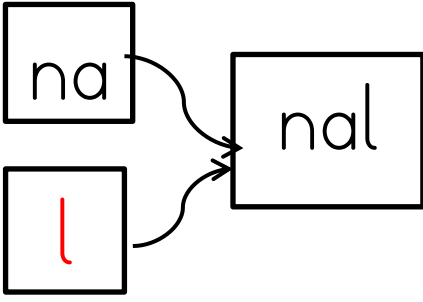

nal

nal

nal

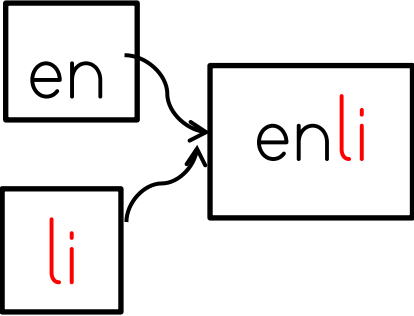

enli

enli

enli

anne

nine

anla

Okuyalım , yazalım.

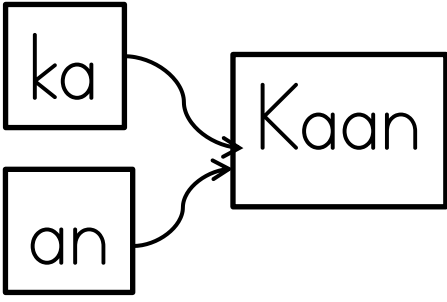

Kaan Kaan

Kaan

Kaan

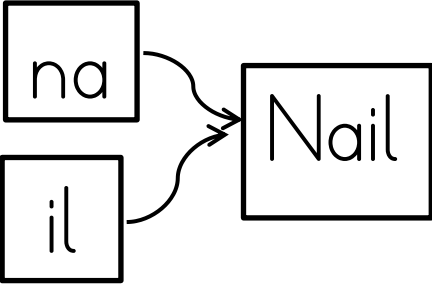

Nail Nail Nail

Nail

Nail

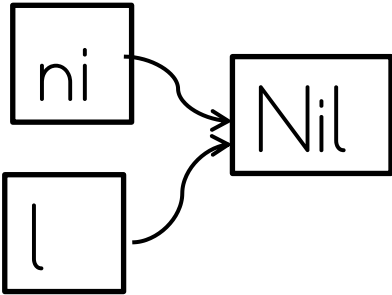

Nil

Nil

Nil

Okuyalım , yazalım.

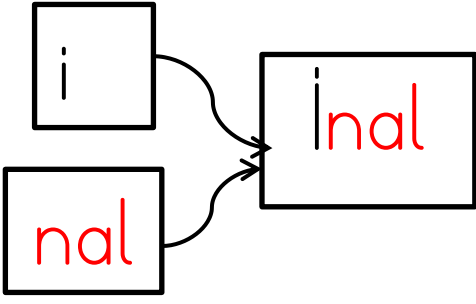

İnal İnal İnal

İnal

İnal

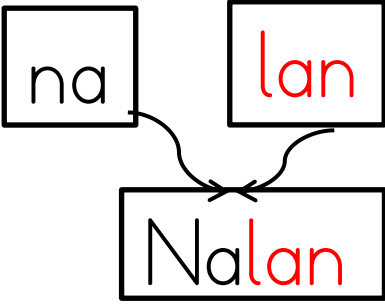

Nalan Nalan

Nalan

Nalan

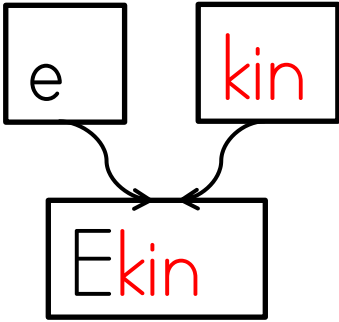

Ekin Ekin Ekin

Ekin

Ekin

Okuyalım , yazalım.

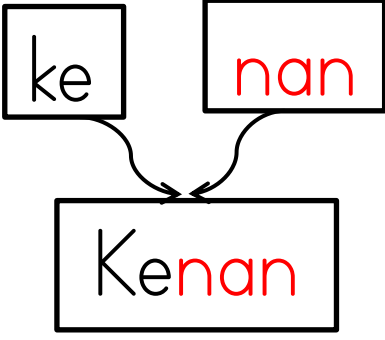

Kenan Kenan

Kenan

Kenan

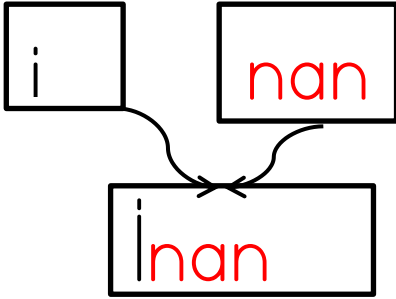

İnan İnan İnan

İnan

İnan

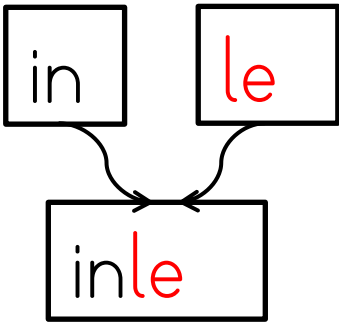

İnle inle inle inle

İnle

İnle

Okuyalım , yazalım.

ni ne ni

nineni

nineni nineni

nineni

nineni

an ne ni

anneni

Anneni anneni

anneni

anneni

e li ne

eline

eline eline

eline

eline

Okuyalım , yazalım.

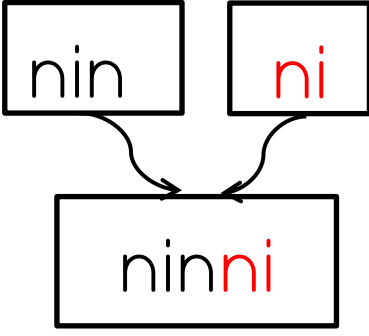

ninni ninni

ninni

ninni

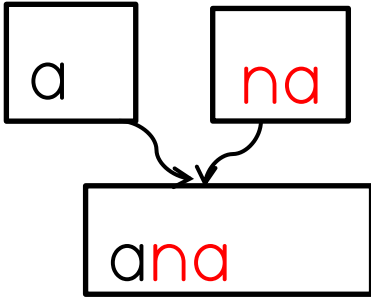

Ana ana ana

ana

ana

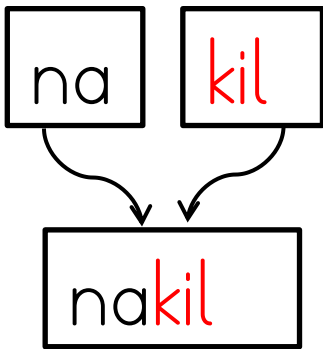

nakil nakil

nakil

nakil

Okuyalım , yazalım.

a lan  
alan

alan alan alan

alan

alan

i lik  
ilik

ilik ilik ilik ilik

ilik

ilik

la kin  
lakin

lakin lakin

lakin

lakin



Okuyalım , yazalım.

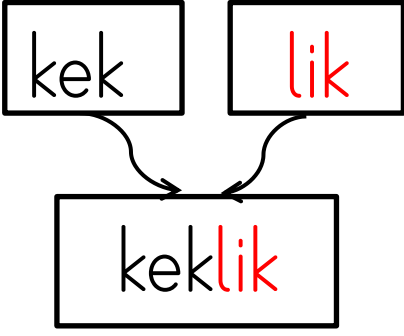

keklik    keklik

keklik

keklik

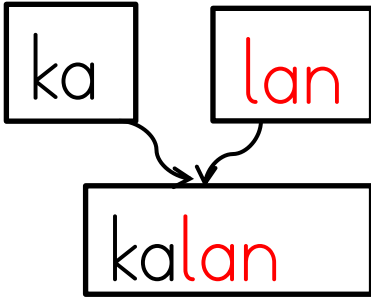

kalan    kalan

kalan

kalan

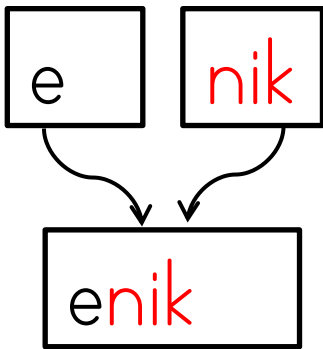

enik    enik    enik

enik

enik

Okuyalım , yazalım.

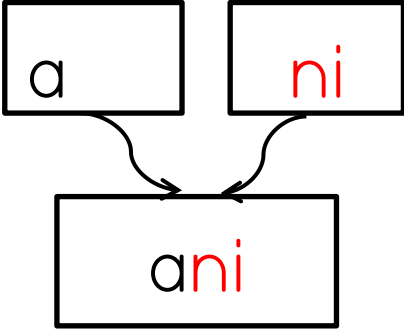

ani ani ani

ani

ani

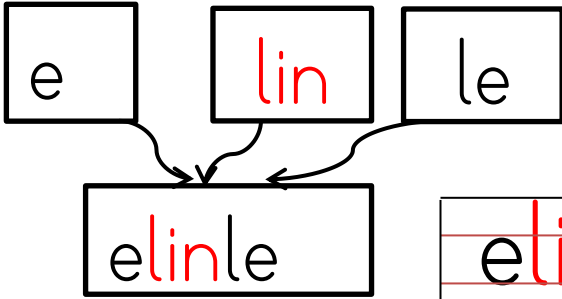

elinle elinle

elinle

elinle

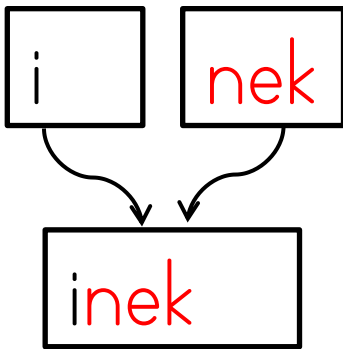

inek inek inek

inek

inek

Okuyalım, yazalım.

Anne nane ek.

Nil nineni anla.

Kenan inek al.

Kaan eline nal al.

Okuyalım, yazalım.

Ekin 4 nane ek.

Nalan iki inek al.

Nail inek al.

Okuyalım, yazalım.

Nalan, Nail'e keklük al.

Nine Nil'e kek al.

İnan Nail inan.

Kenan iki nal al.

Okuyalım , yazalım.

Nil , İna'la inan.

Ali elinle nane ek.

Annene ala inek al.

Okuyalım , yazalım.

Nalan ile ekin ek.

Ninen ile nane ek.

Ninene nane al.

Metni üç kere okuyup yazalım. . Her okumada bir yıldız boyayalım.

## NALAN

Nalan nane al.

Ninene nane al.

Annene nane al.

Eline nane al.

Al Nalan al.

Nane al ,ek.

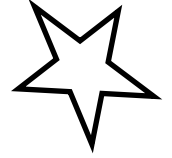
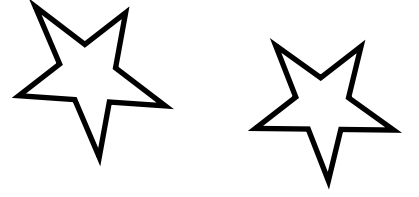











Metni üç kere okuyup yazalım. Her okumada bir yıldız boyayalım.

NANE

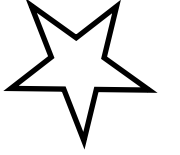

Kenan ek.

Kenan nane ek.

Kenan elli nane ek.

Nane ile kekik ek.

Ninen ile nane ek.

Ek Kenan nane ek.

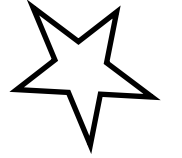
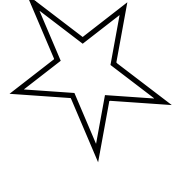









Metni üç kere okuyup yazalım. . Her okumada bir yıldız boyayalım.

NİL

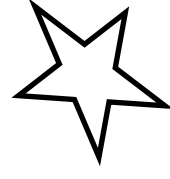
Nil ekin ek.

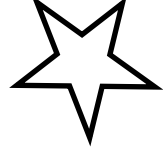

Nalin ile ekin ek.



Ninen ile nane ek.

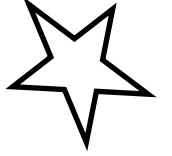

Ek Nil ek.

Nalan'la ninenle ek.

Ninene nane ek.







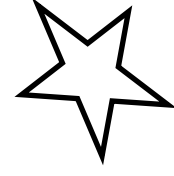

Metni üç kere okuyup yazalım. . Her okumada bir yıldız boyayalım.

EKİN

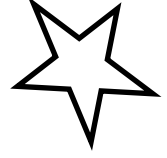

Ekin nane al.

Ninene nane al.



Annene nane al.

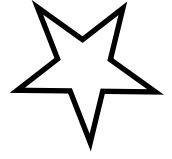

Al Ekin al.

Elli nane al.

İki elinle al.









Metni üç kere okuyup yazalım. . Her okumada bir yıldız boyayalım.

# İNEK

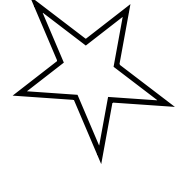
Ekin inek al.

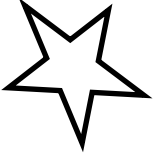

Annene inek al.



Ala inek al.

Ak inek al.

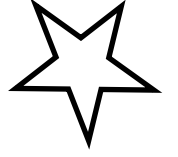

Al Ekin al.

Annene ala inek al.









Metni üç kere okuyup yazalım. . Her okumada bir yıldız boyayalım.

## KEK

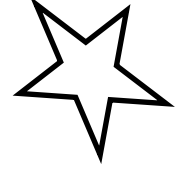
Nalan kek al.

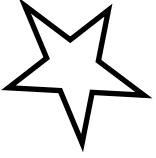

Nil'e kek al.



Nil'e iki kek al.

Nil'e naneli kek al.

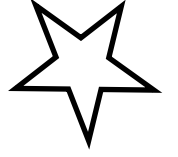

Keke nane ekle.



